

DB Netz Niederlassung Südwest

Fahrpläne Basel Nord Sued ab 05.09.2016

Jahresfahrplan 2016 vom: 13. Dezember 2015 bis: 10. Dezember 2016
Gültig vom: 05. September 2016 bis: 09. Oktober 2016 / täglich

Fahrpläne Basel Nord Sued ab 05.09.2016

Stunden: 0 - 3

Stunden: 0 - 3

| Basel Bad Bf | |
|---------------|-----|
| Basel SBB P2b | |
| GW6 | |
| P2b | |
| Hauptbahn | |
| 70 <100 > | |
| 4604 | |
| 1.6 | |
| 5.1 | 3.5 |

| Basel Bad Bf | | | |
|---------------------|-----|-----------|-----------|
| Basel Bad Rbf(GR A) | | | |
| | | P2b | |
| | | Hauptbahn | Nebenbahn |
| | | 60 | 80 |
| | | 4405 | 4413 |
| 2.9 | 2.8 | 0.3 | 0.6 |
| | 3.1 | | 0.4 |
| | 2.6 | | |
| | | | 2.2 |
| 0.1 | | | 2.2 |

| Basel Bad Rbf | |
|-----------------------|-------|
| Weil (Rh) - Haltingen | |
| | |
| | |
| GW6 | |
| L2b und P2b | |
| Hauptbahn | |
| 130 <180 > | |
| 4000 | |
| 180 | |
| 2.0 | 1.1 |
| 2.8 | 2.3 |
| 270.7 | 284.3 |

| Basel Bad Rbf | |
|-----------------|-----|
| Weil (Schlaufe) | |
| | |
| | |
| P2b | |
| Nebenbahn | |
| 60 | |
| 4411 | |
| 2.7 | |
| | 0.8 |
| 3.5 | |

| Basel Bad Rbf | |
|----------------|-----|
| Weil (Sig N10) | |
| | |
| | |
| P2b | |
| Hauptbahn | |
| 60 | |
| 4415 | |
| 1.3 | |
| | 1.3 |
| 0.0 | |

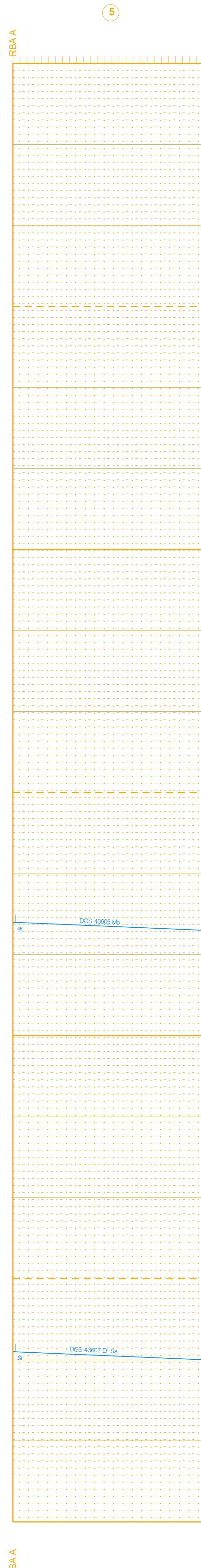
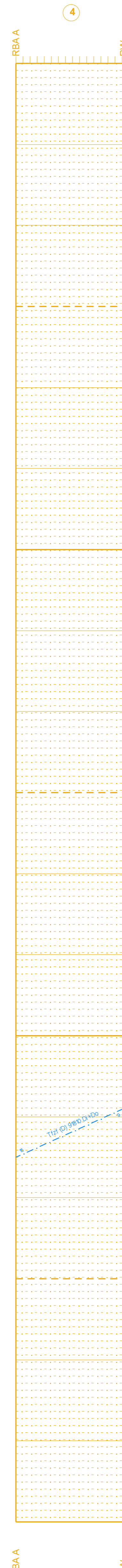
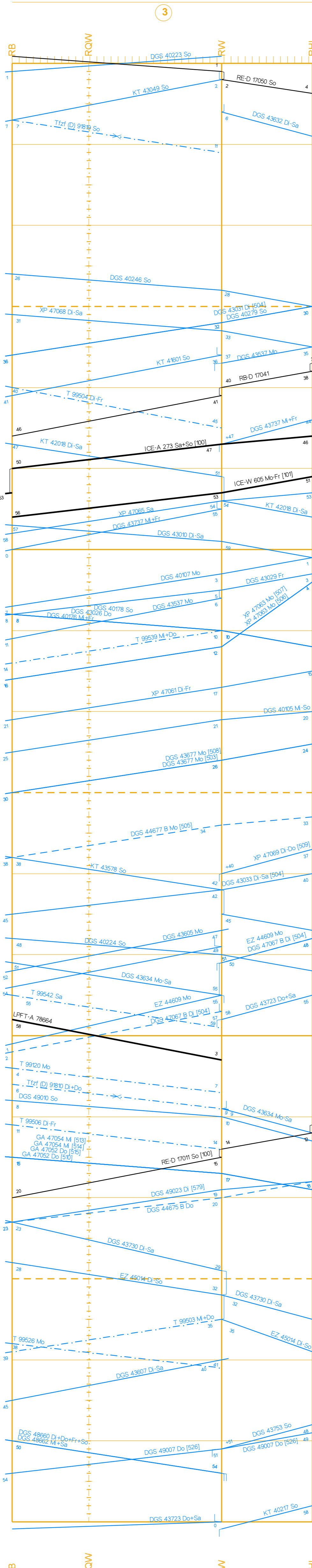
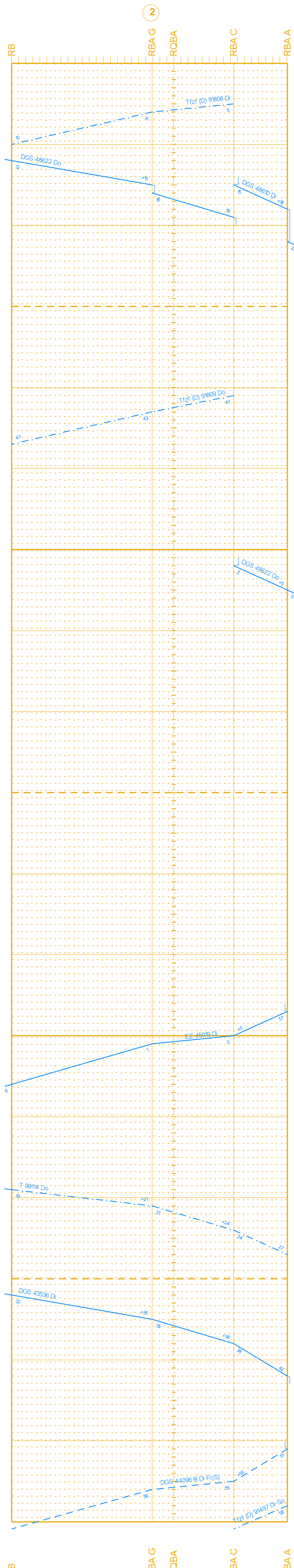
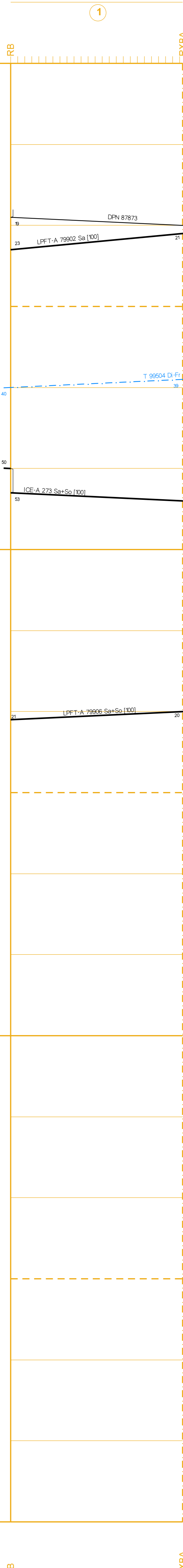

[100] auch: 3.10.16 [503] verkehrt nur am 5.9.16 [515] 5.9.16 - 24.9.16 Di
 [101] nicht: 3.10.16 [504] nicht: 4.10.16 [526] 6.9.16 - 9.10.16 Do
 [505] nicht: 3.10.16 [506] nicht: 3.10.16 [526] 6.9.16 - 9.10.16 Do
 [506] nicht: 3.10.16 [507] nicht: 3.10.16 [526] 6.9.16 - 9.10.16 Di
 [507] 5.9.16 - 13.9.16 Mo [508] 14.9.16 - 9.10.16 Mo
 [508] 14.9.16 - 9.10.16 Mo [509] 5.9.16 - 13.9.16 Mo
 [509] 5.9.16 - 13.9.16 Mo [510] 6.9.16 - 9.10.16 Do
 [510] 6.9.16 - 9.10.16 Do [511] 25.9.16 - 9.10.16 Mo
 [511] 25.9.16 - 9.10.16 Mo [512] 5.9.16 - 24.9.16 Mo
 [512] 5.9.16 - 24.9.16 Mo

| Basel Bad Bf Basel SBB Pbf | |
|-------------------------------|-----|
| GWB | |
| P2B | |
| Hauptbahn | |
| 70 <100 > | |
| 4404 | |
| 1.6 | |
| 5.1 | 3.5 |

BAV 520

| Basel Bad Bf Basel Bad Rbf(GR A) | | |
|-------------------------------------|-----------|-----------|
| | P2B | |
| | Hauptbahn | Nebenbahn |
| | 60 | 80 |
| 2.9 | 4405 | 4413 |
| | 0.3 | 0.6 |
| | 3.1 | 2.6 |
| | | 2.2 |

BAV 508 / 1

BAV 508 / 2

| Basel Bad Rbf Weil (Rh) - Haltingen | | |
|--|-------------|-------|
| | GWB | |
| | L2B und P2B | |
| | Hauptbahn | |
| | 130 <160 > | 180 |
| 2.9 | 4000 | 2.3 |
| | 1.1 | |
| 287.7 | | 287.9 |
| | | 294.3 |

BAV 521 / 1

| Basel Bad Rbf Weil (Schlaufe) | |
|----------------------------------|-----------|
| | P2B |
| | Nebenbahn |
| | 60 |
| | 4411 |
| | 2.7 |
| 3.5 | 0.8 |

3.5

| Basel Bad Rbf Weil (Sig N10) | |
|---------------------------------|-----------|
| | P2B |
| | Hauptbahn |
| | 60 |
| | 4415 |
| | 1.3 |
| 0.0 | 1.3 |

0.0

Basel Bad Bf
BR Einf SBB Pbf

Basel Bad Bf
BR Rbf -Gr-L
Basel Rbf LGr
BR Rbf -Gr-C
BR Rbf -Gr-A

Basel Bad Bf
Weil (Rhein) LGr
Weil am Rhein
Haltingen

BR Rbf -Gr-A
Weil am Rhein

BR Rbf -Gr-A
Weil am Rhein

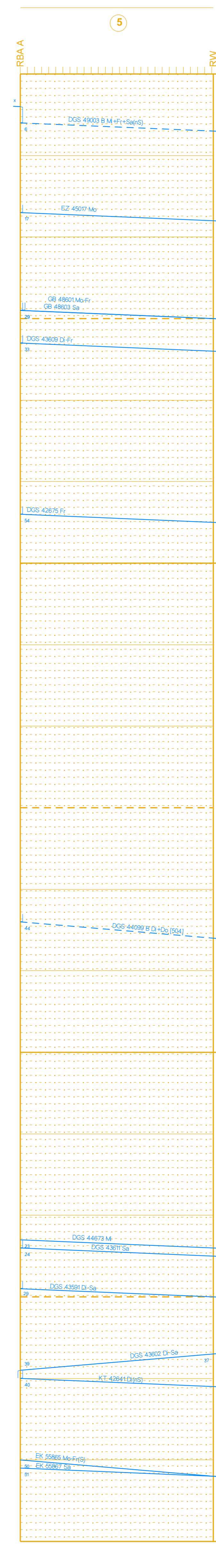
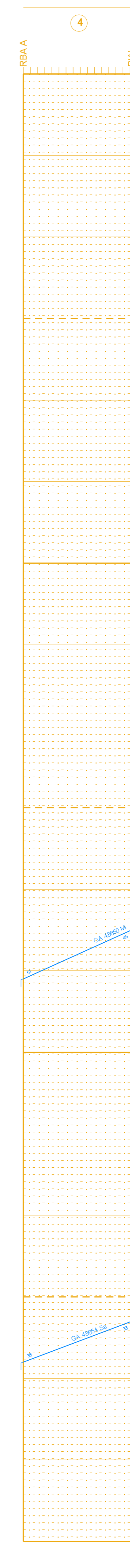
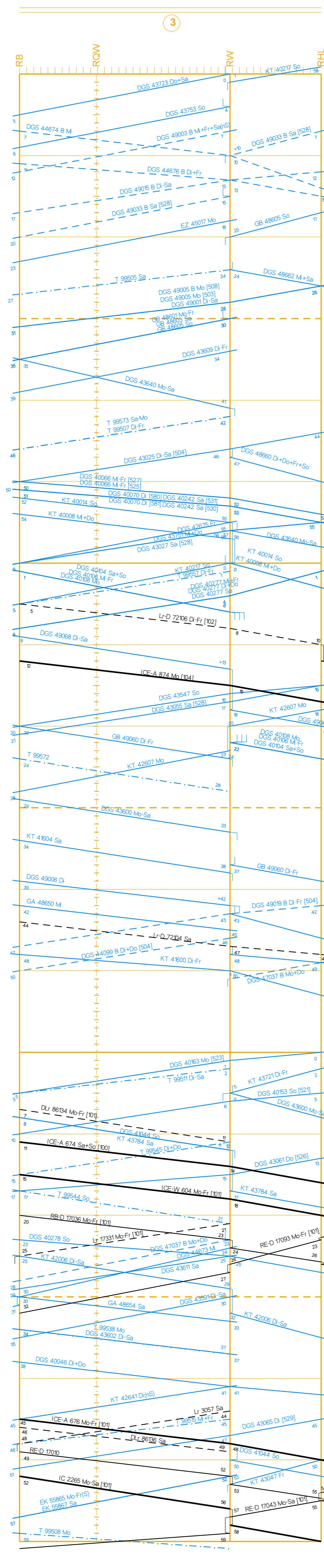
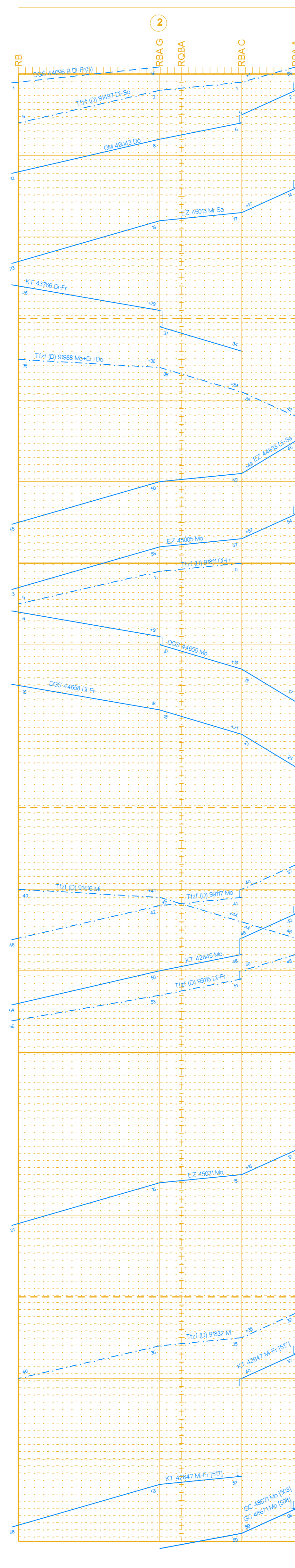

1001 auch: 3.10.16
1011 nicht: 3.10.16
1021 nicht: 3.10.16
1041 nicht: 3.10.16
auch: 4.10.16

503 verkehrt nur am 5.9.16
504 nicht: 4.10.16
506 6.9.16 - 9.10.16 Mo
507 6.9.16 - 9.10.16 Mi-Fr
508 5.10.16 - 9.10.16 So
509 5.9.16 - 1.10.16 Mo
510 nicht: 5.9.16, 26.9.16
511 5.9.16 - 1.10.16 Mi-Fr
512 6.9.16 - 9.10.16 Do
513 2.10.16 - 9.10.16 Mi-Fr

528 6.9.16 - 9.10.16 Do
529 6.9.16 - 9.10.16 Di
530 2.10.16 - 9.10.16 Sa
531 5.9.16 - 1.10.16 So
532 5.9.16 - 1.10.16 Di
533 2.10.16 - 9.10.16 Do

534 5.9.16 - 1.10.16 Mi-Fr
535 6.9.16 - 9.10.16 Do
536 2.10.16 - 9.10.16 Mi-Fr

537 6.9.16 - 9.10.16 Mo
538 5.10.16 - 9.10.16 So
539 5.9.16 - 1.10.16 Di
540 nicht: 5.9.16, 26.9.16
541 5.9.16 - 1.10.16 Mi-Fr
542 6.9.16 - 9.10.16 Do
543 2.10.16 - 9.10.16 Mi-Fr

Fahrpläne Basel Nord Sued ab 05.09.2016

Stunden: 9 - 12

| Basel Bad Bf Basel SBB Pb | |
|------------------------------|--|
| GWB | |
| P2B | |
| Hauptbahn | |
| 70 <100 > | |
| 4404 | |
| 1.6 | |
| 3.5 | |

BAV 520

Basel Bad Bf
BR Einf SBB PB

| Basel Bad Bf Basel Bad Rbf(GR A) | |
|-------------------------------------|--|
| P2B | |
| Hauptbahn | |
| 60 | |
| 4405 | |
| 2.9 | |
| 2.8 | |
| 3.1 | |
| 0.8 | |
| 2.6 | |
| 2.2 | |

BAV 508 / 1

BAV 508 / 2

Basel Bad Bf
BR Rbf -Gr-L
Basel Rbf LGr
BR Rbf -Gr-C
BR Rbf -Gr-A

DB Netz

Niederlassung Südwest

Jahresfahrplan 2016 vom: 13. Dezember 2015 bis: 10. Dezember 2016
Gültig vom: 05. September 2016 bis: 09. Oktober 2016 / täglich

| Basel Bad Rbf Weil (Rh) - Haltingen | |
|--|--|
| GWB | |
| L2B und P2B | |
| Hauptbahn | |
| 130 <160 > | |
| 4000 | |
| 180 | |
| 2.0 | |
| 2.8 | |
| 1.1 | |
| 2.3 | |
| 2.8 | |

BAV 521 / 1

Basel Bad Bf
Weil (Rhein) LGr
Weil am Rhein
Haltingen

| Basel Bad Rbf Weil (Schlaufe) | |
|----------------------------------|--|
| P2B | |
| Hauptbahn | |
| 60 | |
| 4411 | |
| 2.7 | |
| 0.8 | |

BR Rbf -Gr-A
Weil am Rhein

Fahrpläne Basel Nord Sued ab 05.09.2016

Stunden: 9 - 12

| Basel Bad Rbf Weil (Sig N10) | |
|---------------------------------|--|
| P2B | |
| Hauptbahn | |
| 60 | |
| 4415 | |
| 1.3 | |
| 1.3 | |

BR Rbf -Gr-A
Weil am Rhein

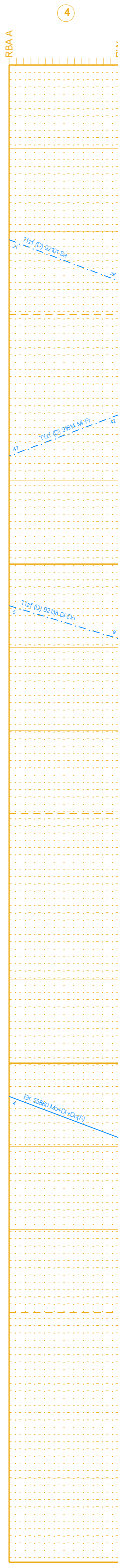
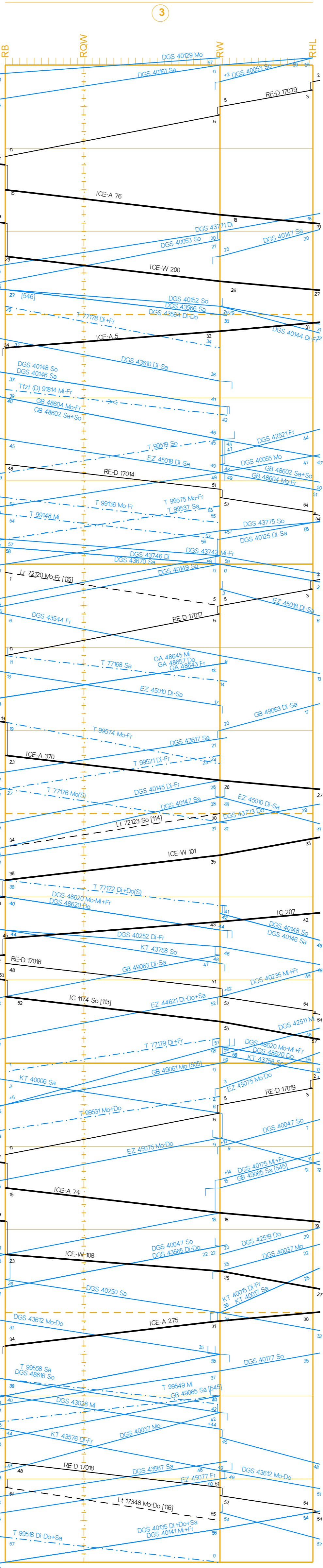
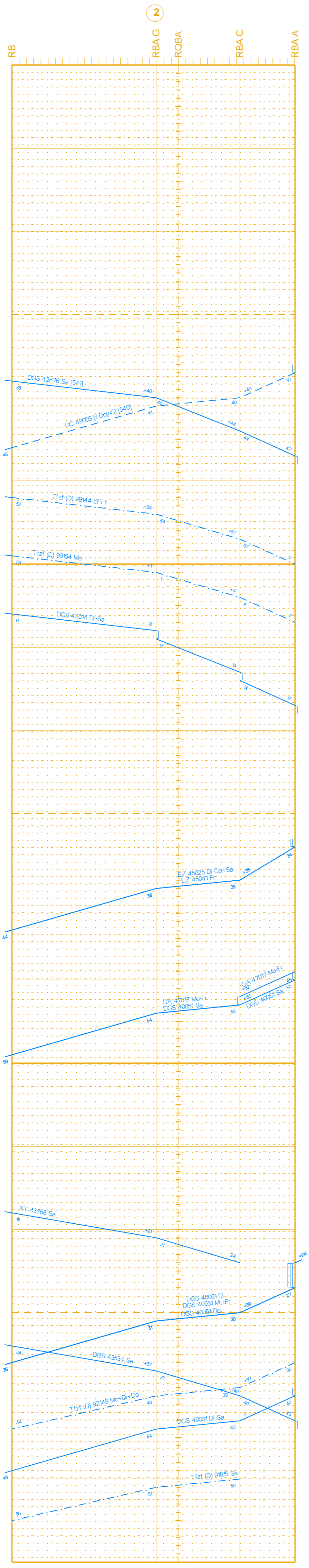
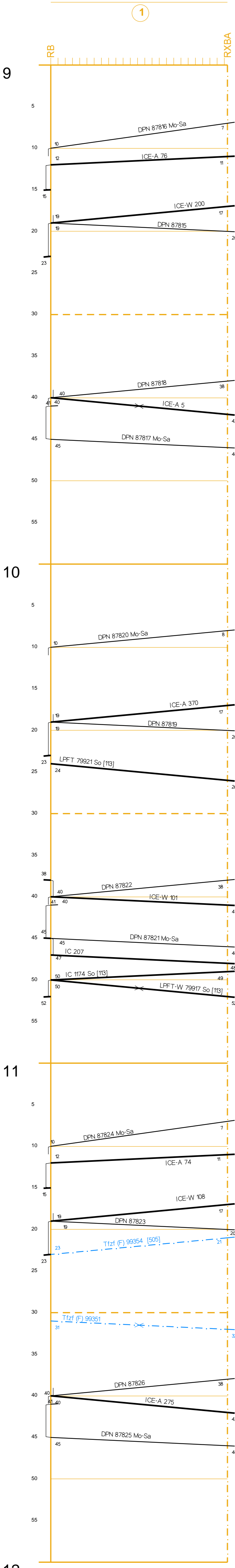

[113] nicht: 2.10.16
[114] auch: 3.10.16
[115] 5.9.16 - 10.9.16 So
[116] 5.9.16 - 20.9.16 Mo-Fr
[117] 12.9.16 - 29.9.16 Mo-Do
[118] nicht: 3.10.16
[119] nicht: 10.9.16, 1.10.16, 8.10.16
[120] nicht: 1.10.16
[121] gegenseitiger Ausschuss mit Zug <4366>

Fahrpläne Basel Nord Sued ab 05.09.2016

Stunden: 12 - 15

DB Netz

Niederlassung Südwest

Jahresfahrplan 2016 vom: 13. Dezember 2015 bis: 10. Dezember 2016
Gültig vom: 05. September 2016 bis: 09. Oktober 2016 / täglich

Fahrpläne Basel Nord Sued ab 05.09.2016

Stunden: 12 - 15

| Basel Bad Bf Basel SBB Pb | |
|------------------------------|-----|
| GWB | |
| P2B | |
| Hauptbahn | |
| 70 <100 > | |
| 4404 | |
| 1.6 | |
| 5.1 | 3.5 |

BAV 520

| Basel Bad Bf Basel Bad Rbf(GR A) | |
|-------------------------------------|-----------|
| | P2B |
| | Hauptbahn |
| | Nebenbahn |
| 60 | 80 |
| 4405 | 4413 |
| 0.3 | 0.4 |
| 2.9 | 2.6 |
| 2.8 | 2.2 |
| 3.1 | |
| 0.8 | |

BAV 508 / 2

| Basel Bad Rbf Weil (Rh) - Haltingen | |
|--|-------------|
| | GWB |
| | L2B und P2B |
| | Hauptbahn |
| 130 <160 > | 180 |
| 4000 | |
| 2.0 | 2.3 |
| 28.7 | 28.3 |
| 1.1 | |

BAV 521 / 1

| Basel Bad Rbf Weil (Schlaufe) | |
|----------------------------------|-----------|
| | P2B |
| | Nebenbahn |
| 60 | |
| 4411 | |
| 2.7 | |
| 3.5 | 0.8 |

BAV 508 / 1

| Basel Bad Rbf Weil (Sig N10) | |
|---------------------------------|-----------|
| | P2B |
| | Hauptbahn |
| 60 | |
| 4415 | |
| 1.3 | |
| 0.0 | 1.3 |

BAV 508 / 2

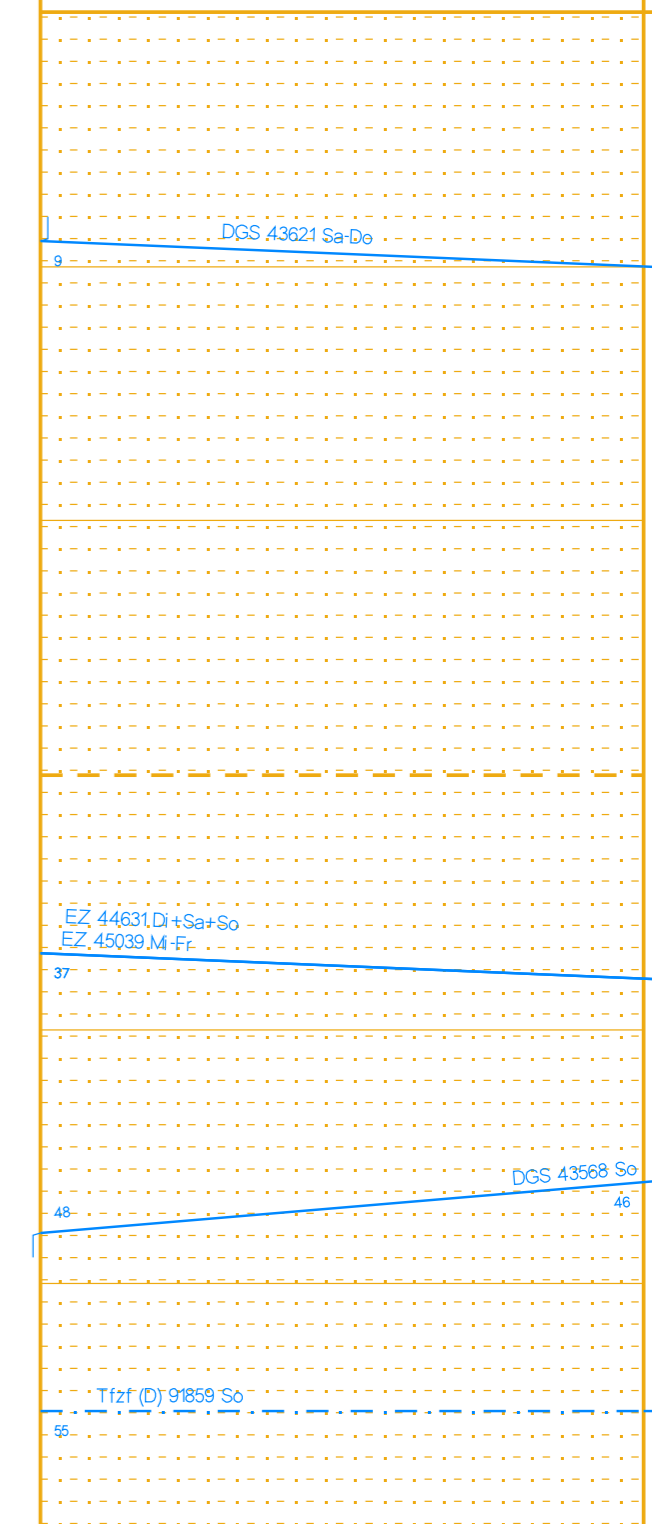
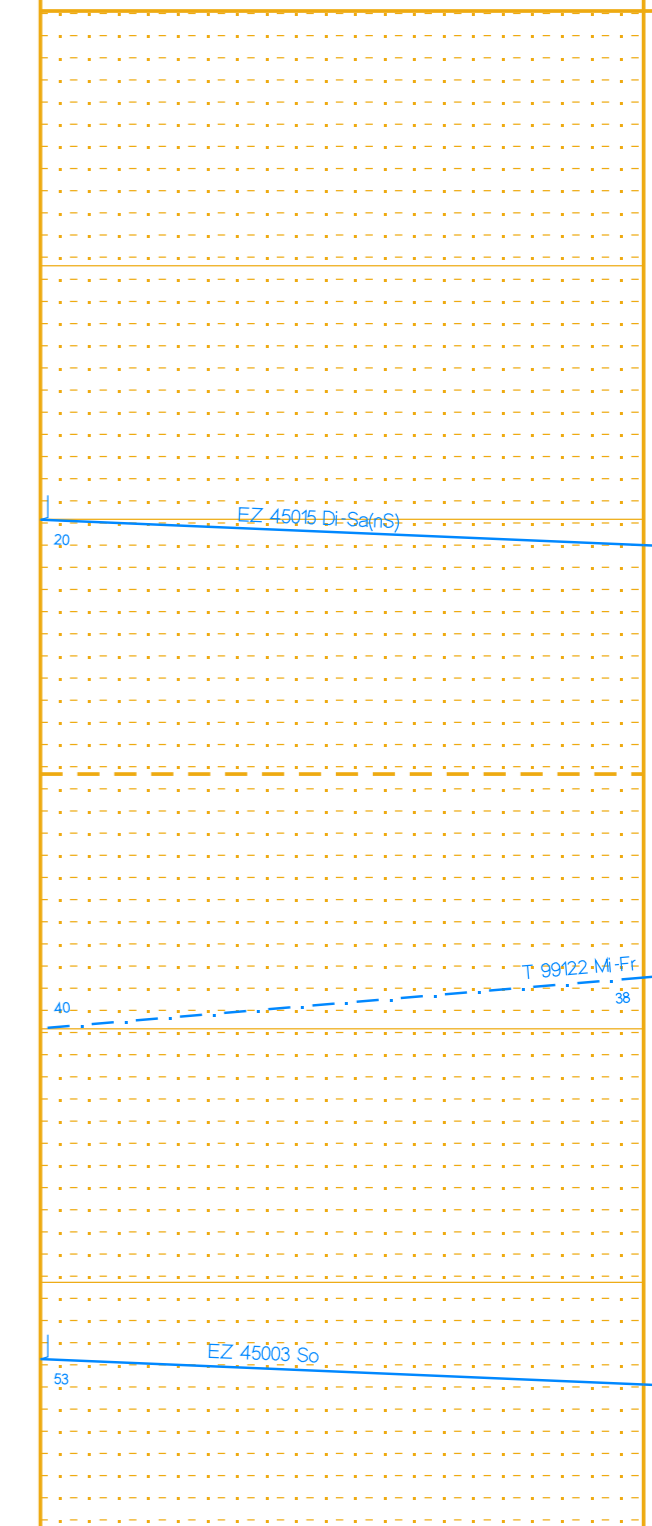
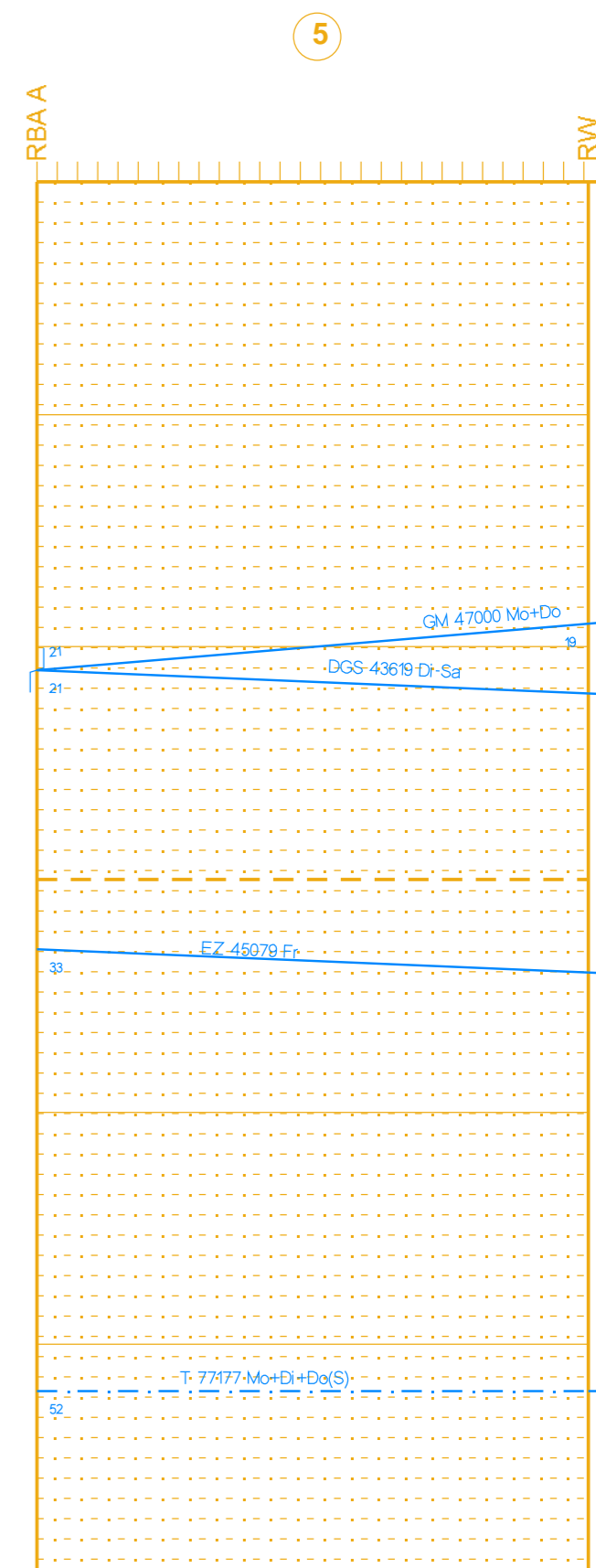
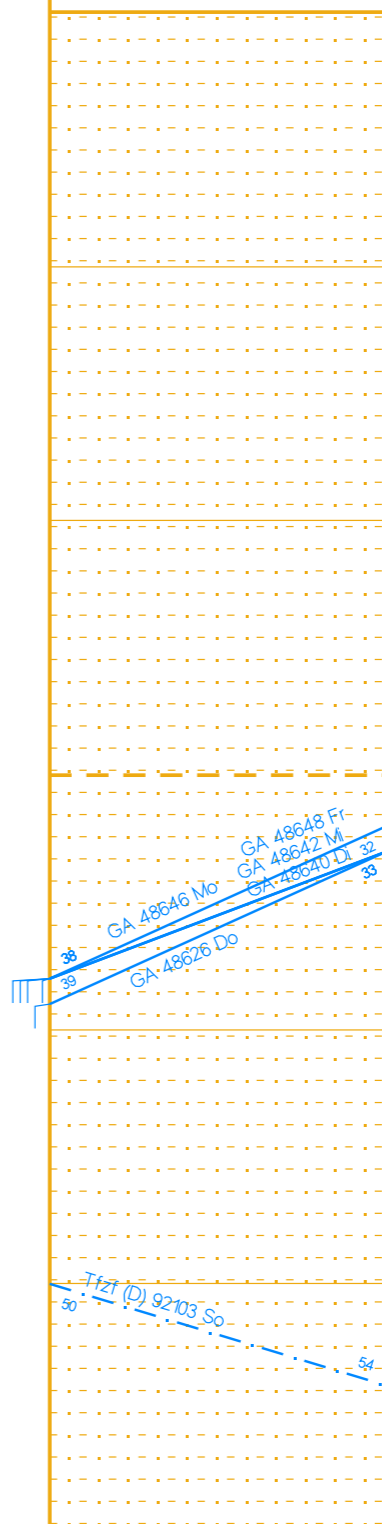
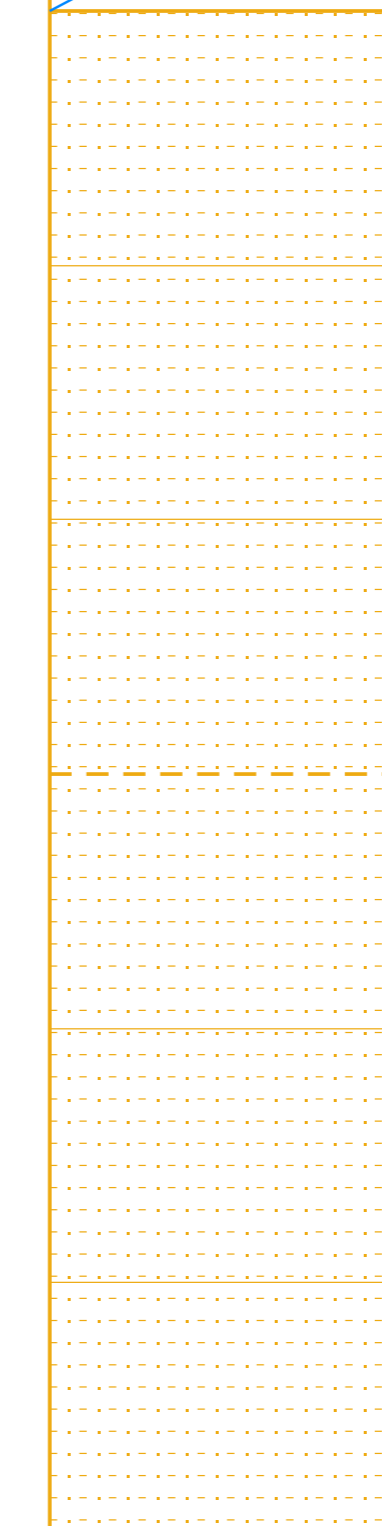
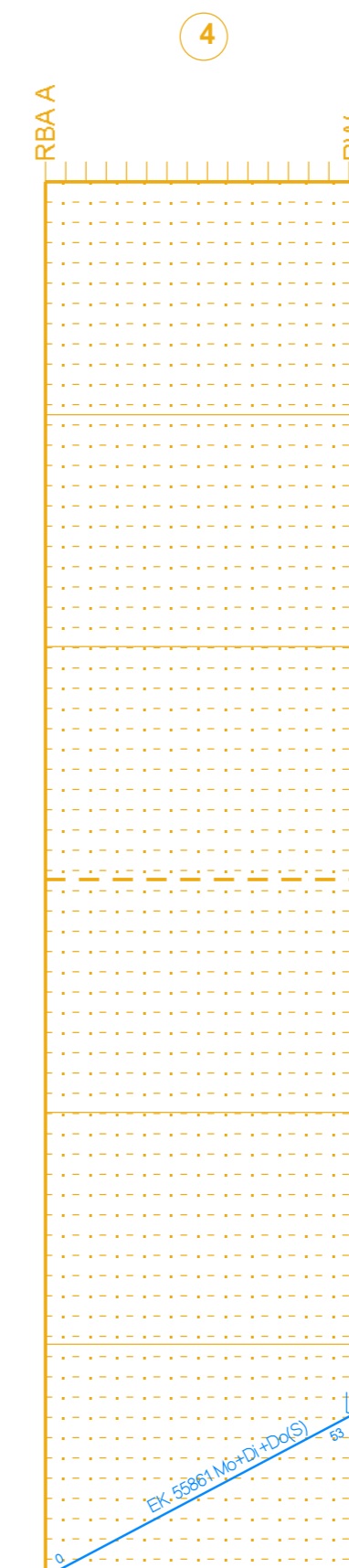
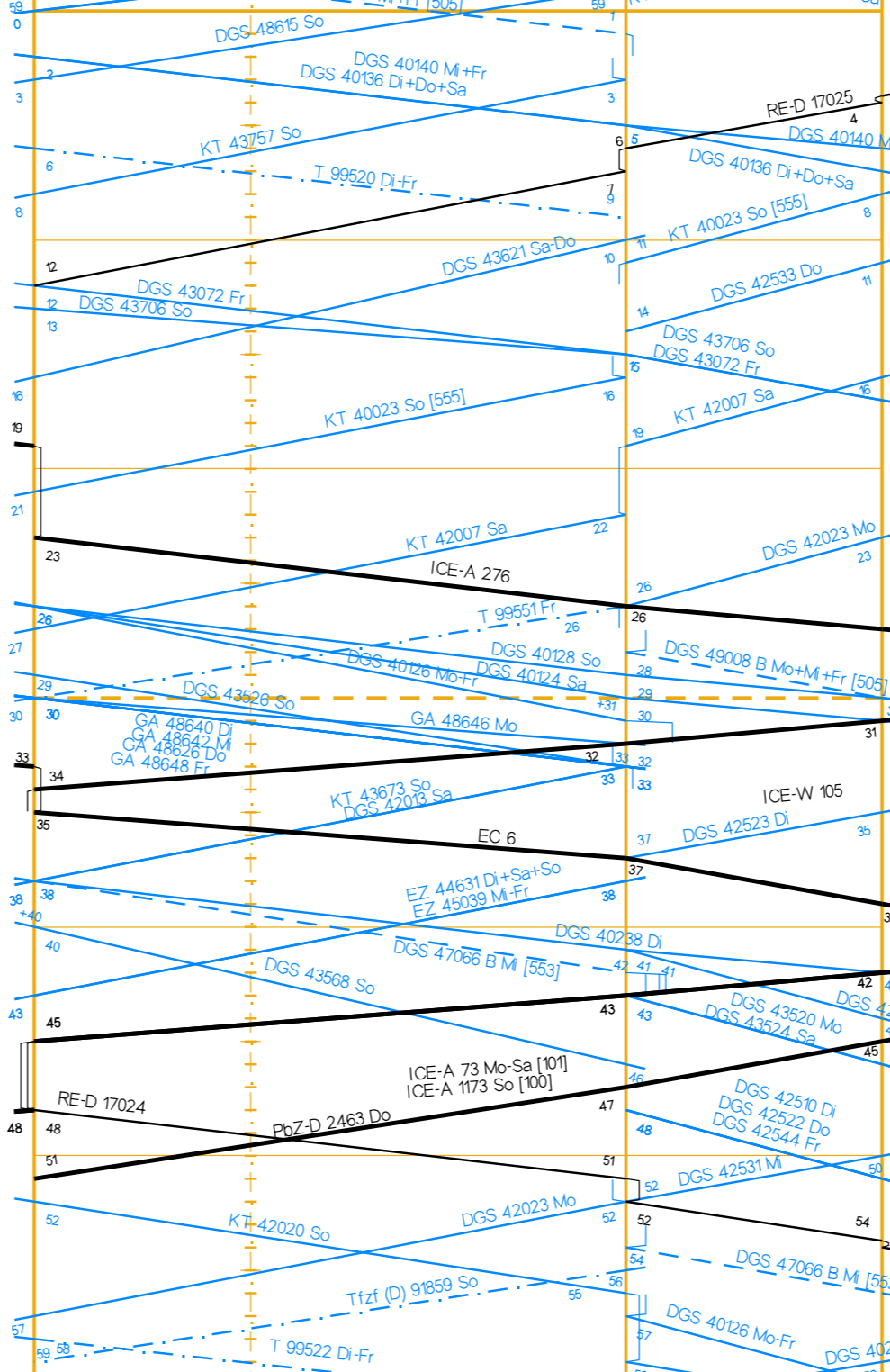
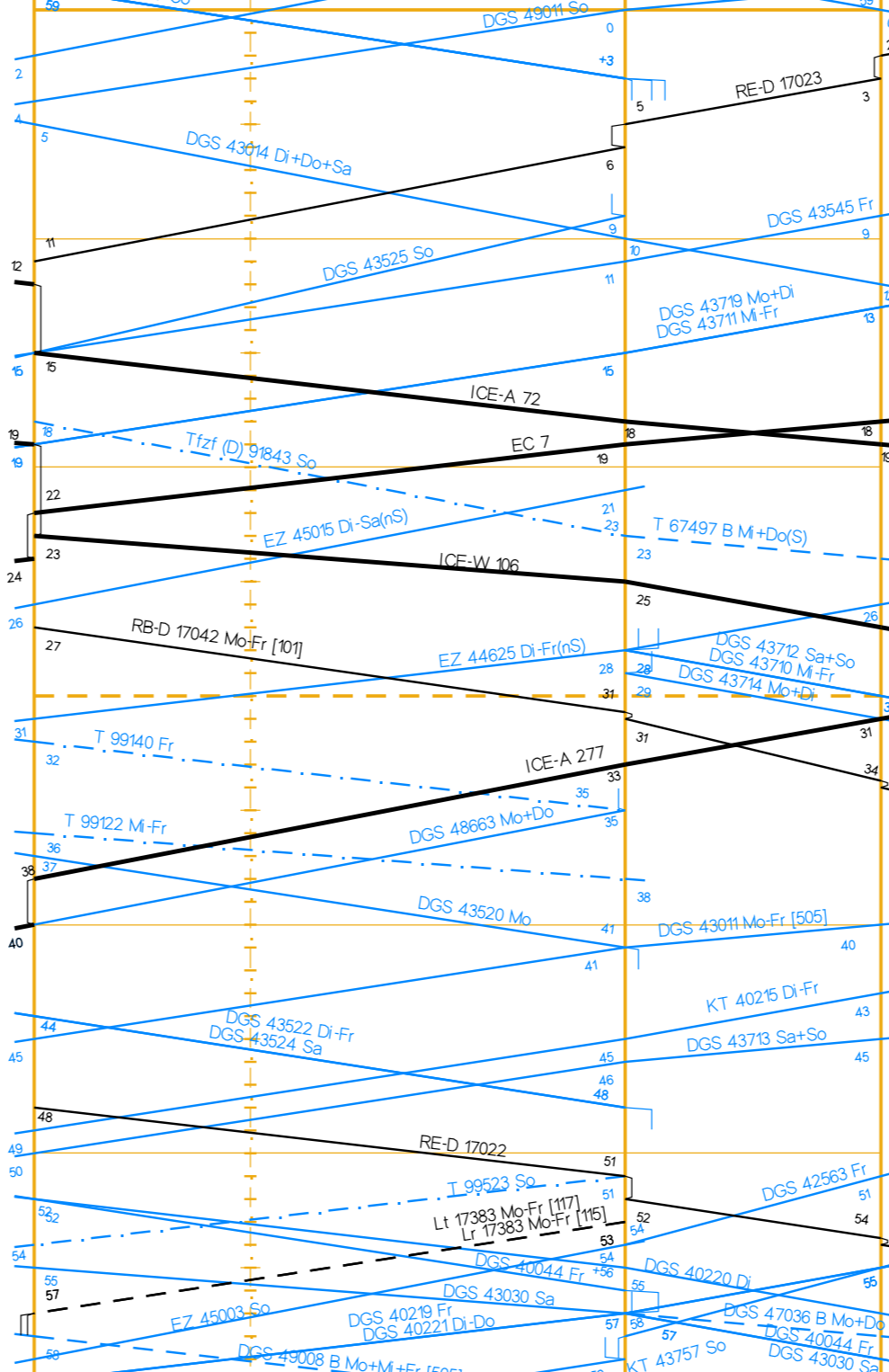
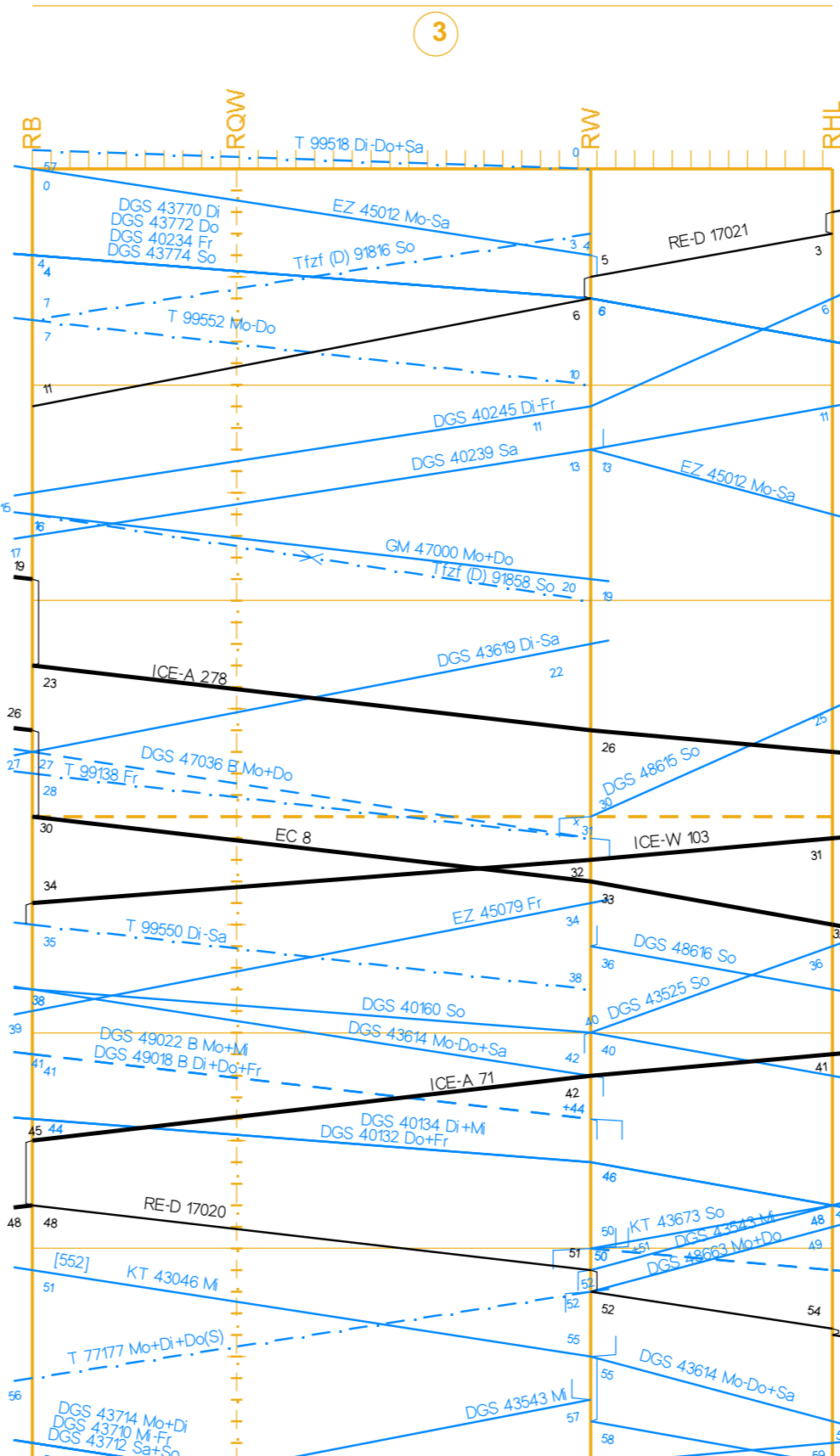
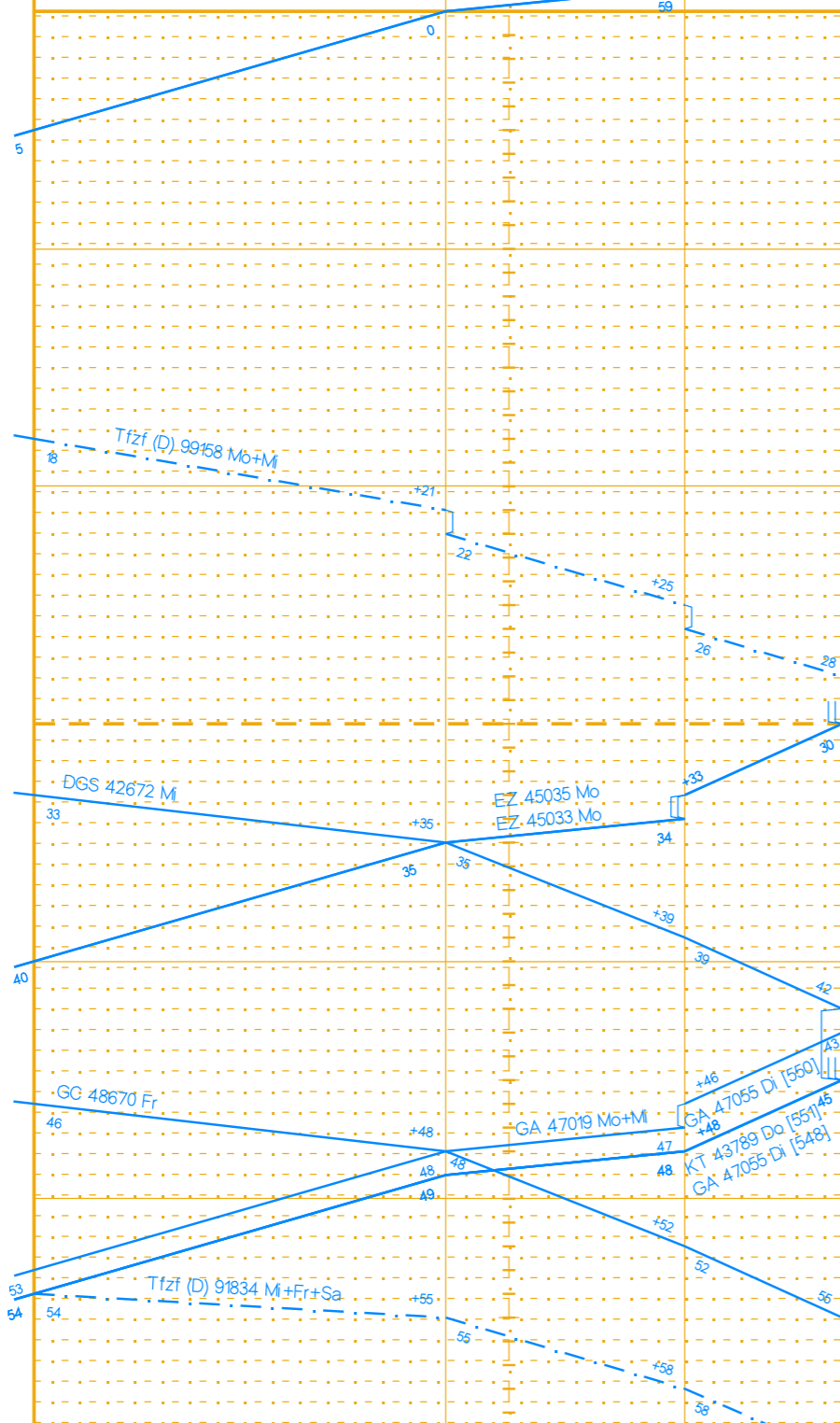
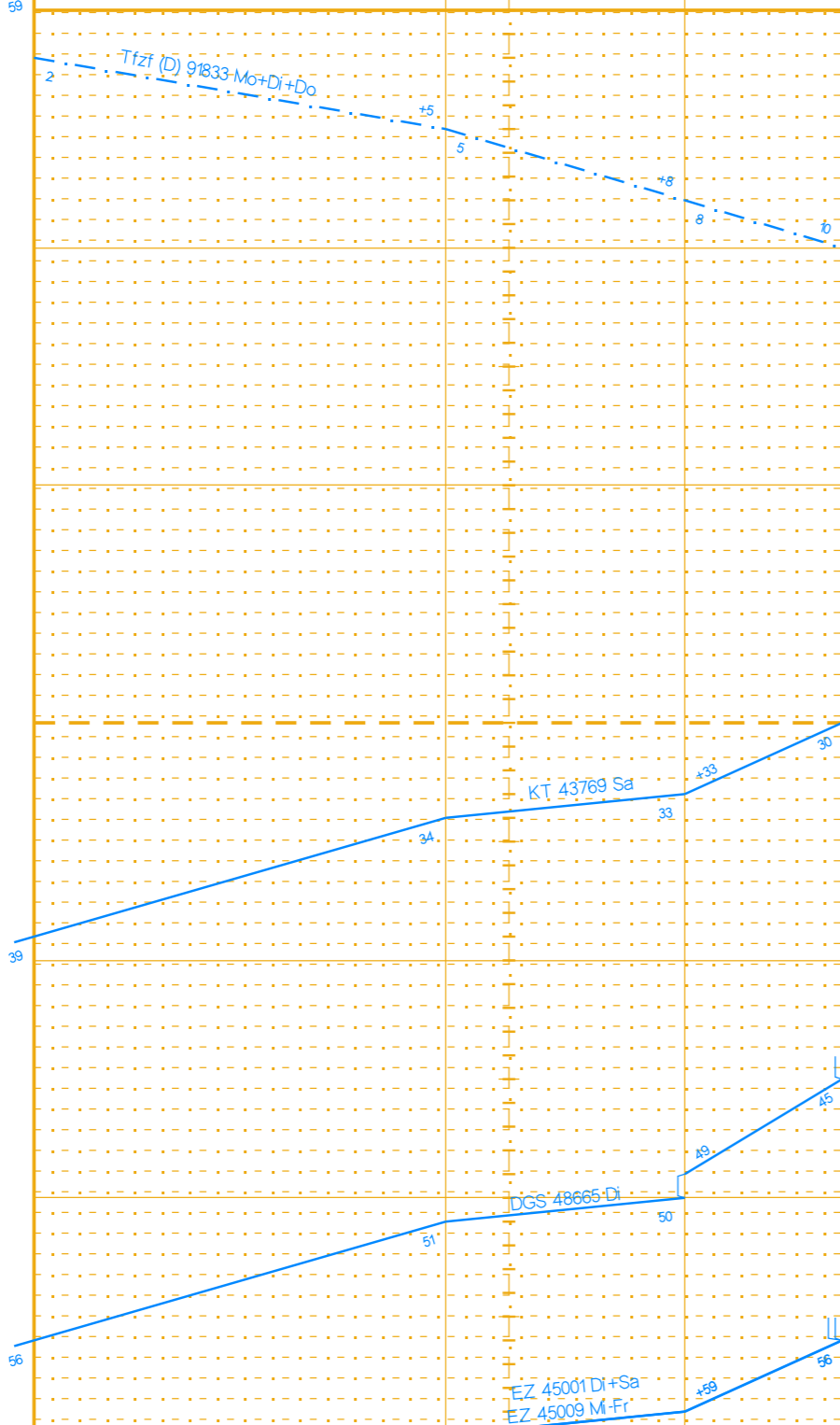
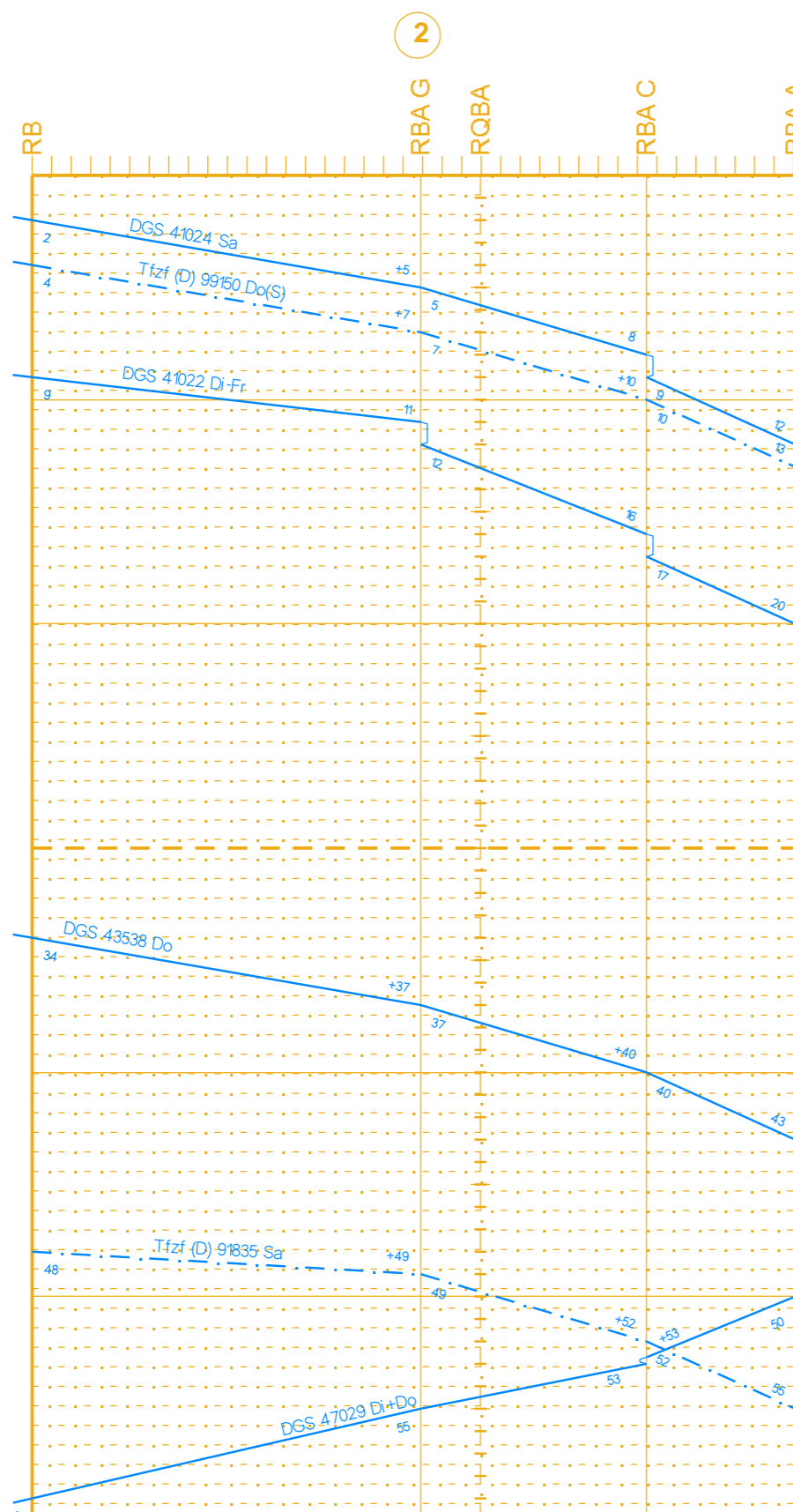
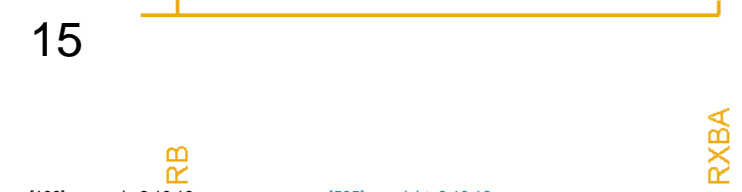
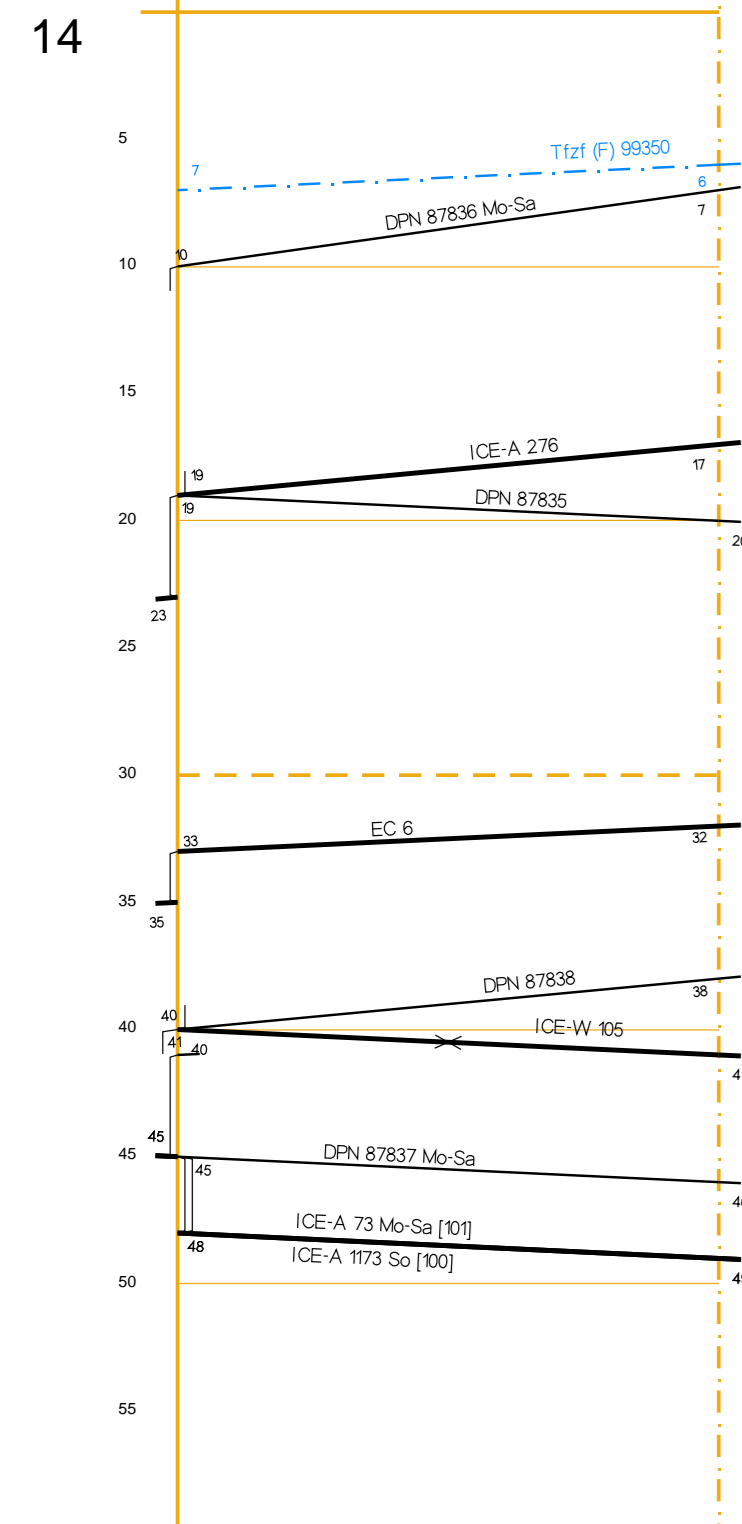
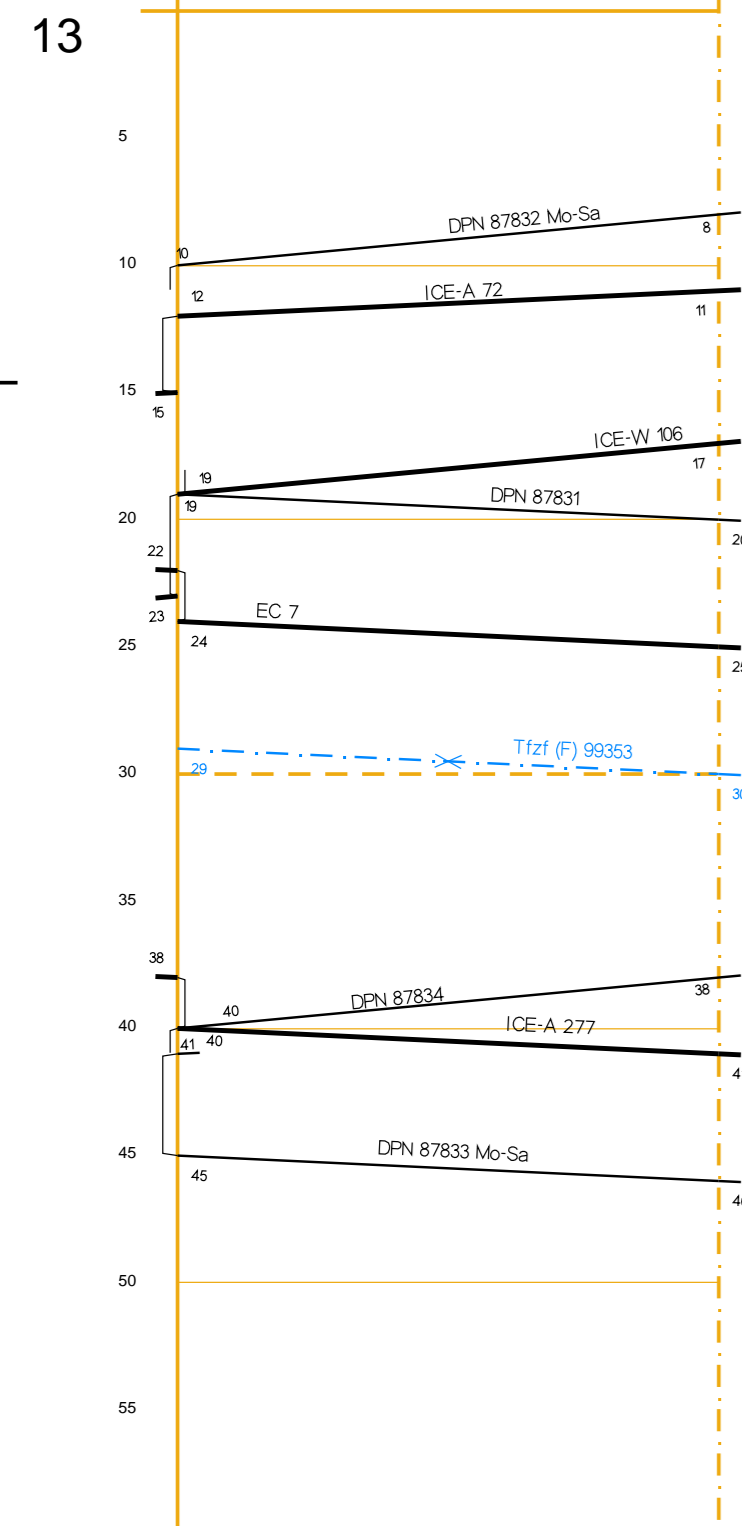
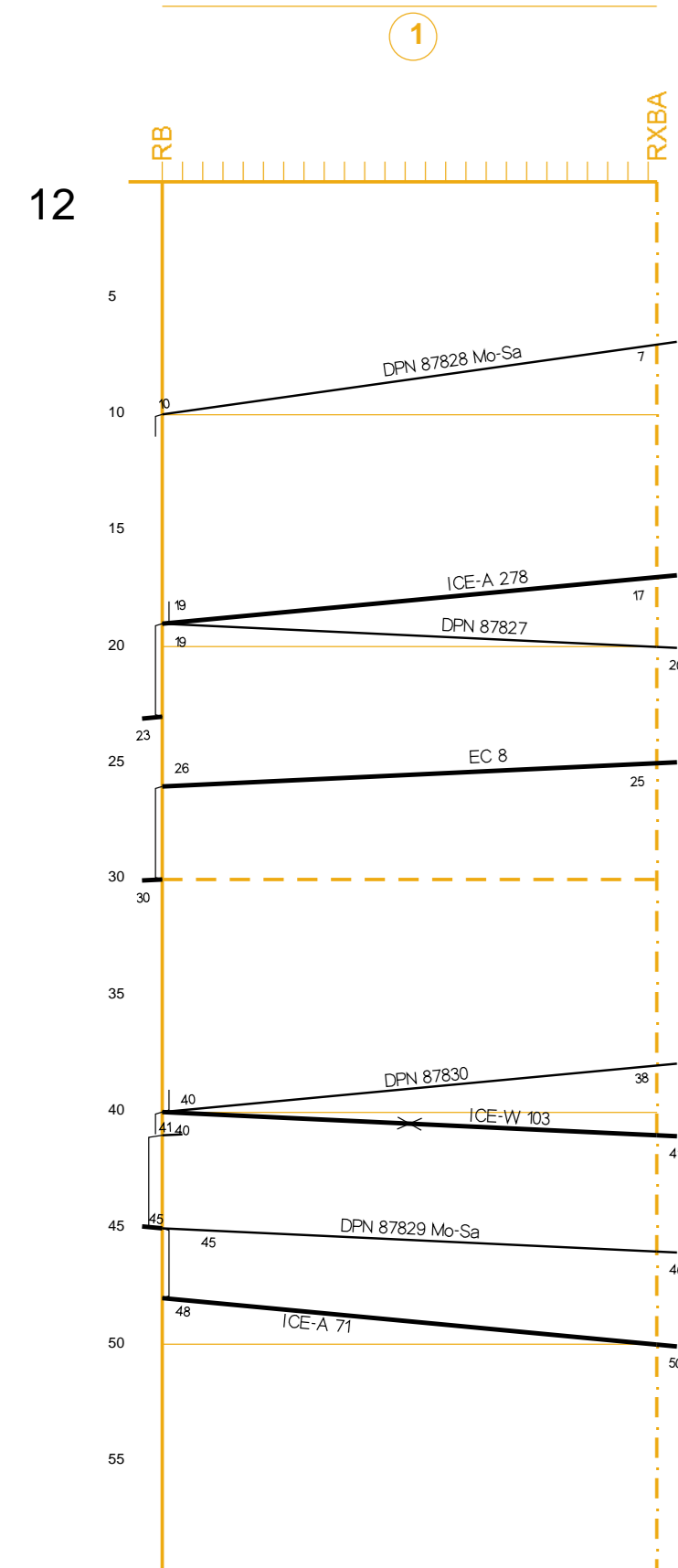

[100] auch: 3.10.16
 [101] nicht: 3.10.16
 [102] 5.9.16 - 30.9.16 Mo-Fr
 [103] 4.10.16 - 9.10.16 Mo-Fr
 [505] nicht: 3.10.16
 [506] 5.9.16 - 24.9.16 Di
 [507] 25.9.16 - 30.9.16 Di
 [508] nicht: 29.10.16
 [509] gegenseitiger Ausschluss mit Zug
 +43859-
 [510] nicht: 5.10.16
 [511] 6.9.16 - 9.10.16 So
 [512] nicht: 3.10.16
 [513] 5.9.16 - 24.9.16 Di
 [514] 25.9.16 - 30.9.16 Di
 [515] nicht: 29.10.16
 [516] gegenseitiger Ausschluss mit Zug
 +43859-
 [517] nicht: 5.10.16
 [518] 6.9.16 - 9.10.16 So

Fahrpläne Basel Nord Sued ab 05.09.2016

Stunden: 18 - 21

| Basel Bad Bf Basel SBB Pb | |
|------------------------------|-----|
| GWB | |
| P2B | |
| Hauptbahn | |
| 70 <100 > | |
| 4404 | |
| 1.6 | |
| 5.1 | 3.5 |

BAV 520



| Basel Bad Bf Basel Bad Rbf (GR A) | |
|--------------------------------------|-----------|
| P2B | |
| Hauptbahn | Nebenbahn |
| 60 | 80 |
| 4405 | 4413 |
| 2.9 | 0.8 |
| 2.9 | 0.8 |
| 3.1 | 0.4 |
| 2.6 | 0.4 |
| 2.2 | 2.2 |

BAV 508 / 1

BAV 508 / 2



DB Netz

Niederlassung Südwest

Jahresfahrplan 2016 vom: 13. Dezember 2015 bis: 10. Dezember 2016

Gültig vom: 05. September 2016 bis: 09. Oktober 2016 / täglich

| Basel Bad Rbf Weil (Rh) - Haltingen | |
|--|-------|
| GWB | |
| L2B und P2B | |
| Hauptbahn | |
| 130 <160 > | 180 |
| 2.0 | 4.000 |
| 2.9 | 1.1 |
| 2.9 | 2.3 |
| 2.9 | 2.9 |

BAV 521 / 1



| Basel Bad Rbf Weil (Schlaufe) | |
|----------------------------------|-----|
| P2B | |
| Nebenbahn | |
| 60 | |
| 4411 | |
| 2.7 | |
| 3.5 | 0.8 |



Fahrpläne Basel Nord Sued ab 05.09.2016

Stunden: 18 - 21

| Basel Bad Rbf Weil (Sig N10) | |
|---------------------------------|-----|
| P2B | |
| Hauptbahn | |
| 60 | |
| 4415 | |
| 1.3 | |
| 0.0 | 1.3 |

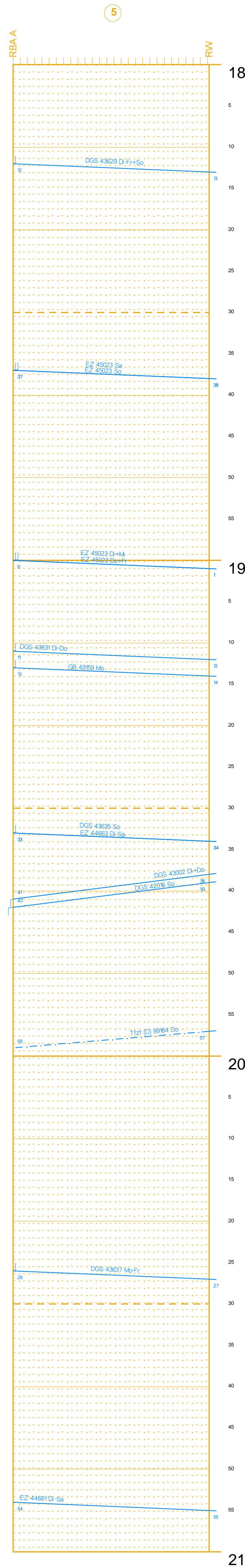
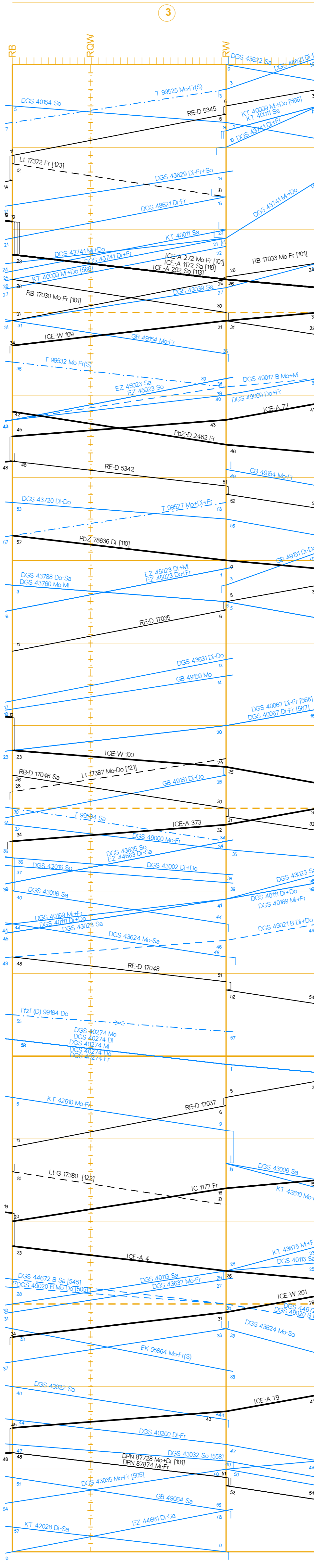
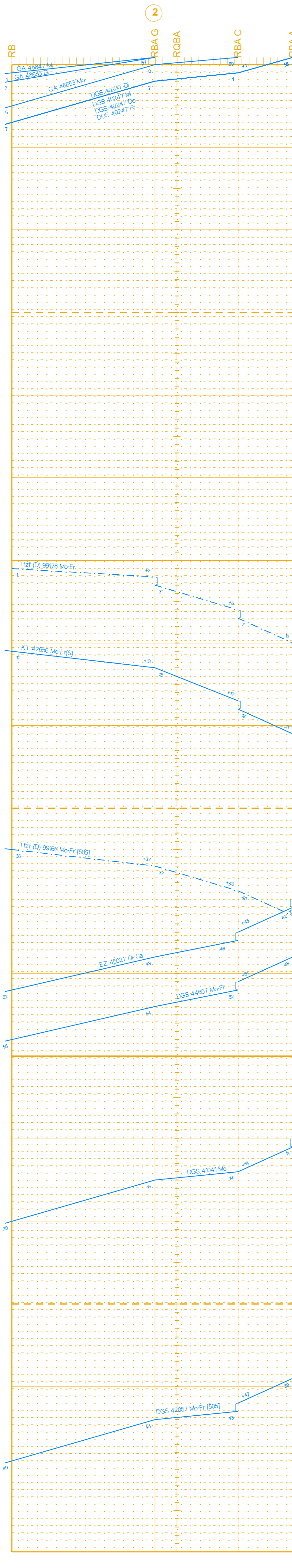
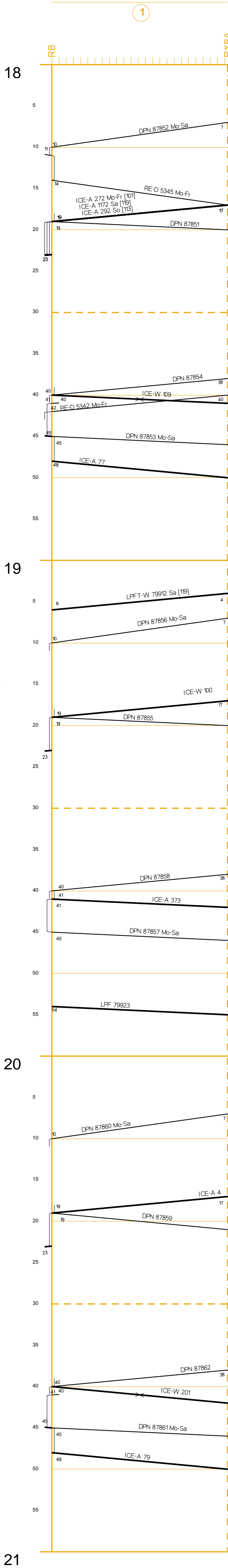
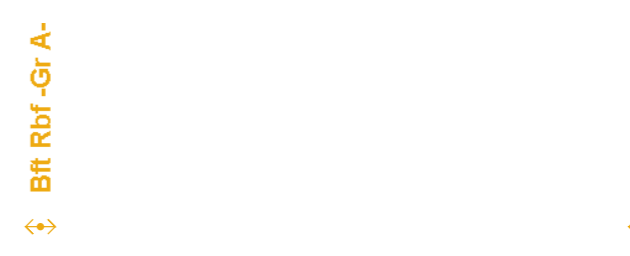

[101] nicht: 3.10.16
 [110] nicht: 6.9.16, 20.9.16, 4.10.16
 [113] nicht: 2.10.16
 auch: 3.10.16
 [119] auch: 2.10.16
 [121] 4.10.16 - 9.10.16 Mo-Do
 [122] 5.9.16 - 11.9.16
 [123] 7.10.16 - 9.10.16 Fr

[505] nicht: 3.10.16
 [545] nicht: 1.10.16
 [565] nicht: 2.10.16
 [566] 6.9.16 - 9.10.16 Mo-Do
 [567] 2.10.16 - 9.10.16 Di-Fr
 [568] 5.9.16 - 1.10.16 Di-Fr

[505] nicht: 3.10.16
 [545] nicht: 1.10.16
 [565] nicht: 2.10.16
 [566] 6.9.16 - 9.10.16 Mo-Do
 [567] 2.10.16 - 9.10.16 Di-Fr
 [568] 5.9.16 - 1.10.16 Di-Fr

[505] nicht: 3.10.16
 [545] nicht: 1.10.16
 [565] nicht: 2.10.16
 [566] 6.9.16 - 9.10.16 Mo-Do
 [567] 2.10.16 - 9.10.16 Di-Fr
 [568] 5.9.16 - 1.10.16 Di-Fr

Fahrpläne Basel Nord Sued ab 05.09.2016

Stunden: 21 - 24

DB Netz

Niederlassung Südwest

Jahresfahrplan 2016 vom: 13. Dezember 2015 bis: 10. Dezember 2016
Gültig vom: 05. September 2016 bis: 09. Oktober 2016 / täglich

Fahrpläne Basel Nord Sued ab 05.09.2016

Stunden: 21 - 24

| Basel Bad Bf Basel SBB Pb | |
|------------------------------|-----|
| GWB | |
| P2B | |
| Hauptbahn | |
| 70 <100 > | |
| 4404 | |
| 5.1 | 3.5 |

BAV 520

| Basel Bad Bf Basel Bad Rbf(GR A) | | |
|-------------------------------------|-----|-----|
| GWB | | |
| P2B | | |
| Hauptbahn | | |
| Nebenbahn | | |
| 60 | | |
| 4413 | | |
| 2.9 | 0.3 | 0.8 |
| 2.8 | 3.1 | 2.6 |
| 2.1 | 0.4 | 2.2 |

BAV 508 / 1

BAV 508 / 2

| Basel Bad Rbf Weil (Rh) - Haltingen | | | |
|--|-----|-----|-----|
| GWB | | | |
| L2B und P2B | | | |
| Hauptbahn | | | |
| 130 <160 > | | | |
| 4000 | | | |
| 180 | | | |
| 2.9 | 1.1 | 2.3 | 2.3 |
| 2.8 | 2.5 | 2.5 | 2.5 |

BAV 521 / 1

| Basel Bad Rbf Weil (Schlaufe) | |
|----------------------------------|-----|
| GWB | |
| P2B | |
| Nebenbahn | |
| 60 | |
| 4411 | |
| 2.7 | 0.8 |

| Basel Bad Rbf Weil (Sig N10) | |
|---------------------------------|-----|
| GWB | |
| P2B | |
| Hauptbahn | |
| 60 | |
| 4415 | |
| 1.3 | 1.3 |

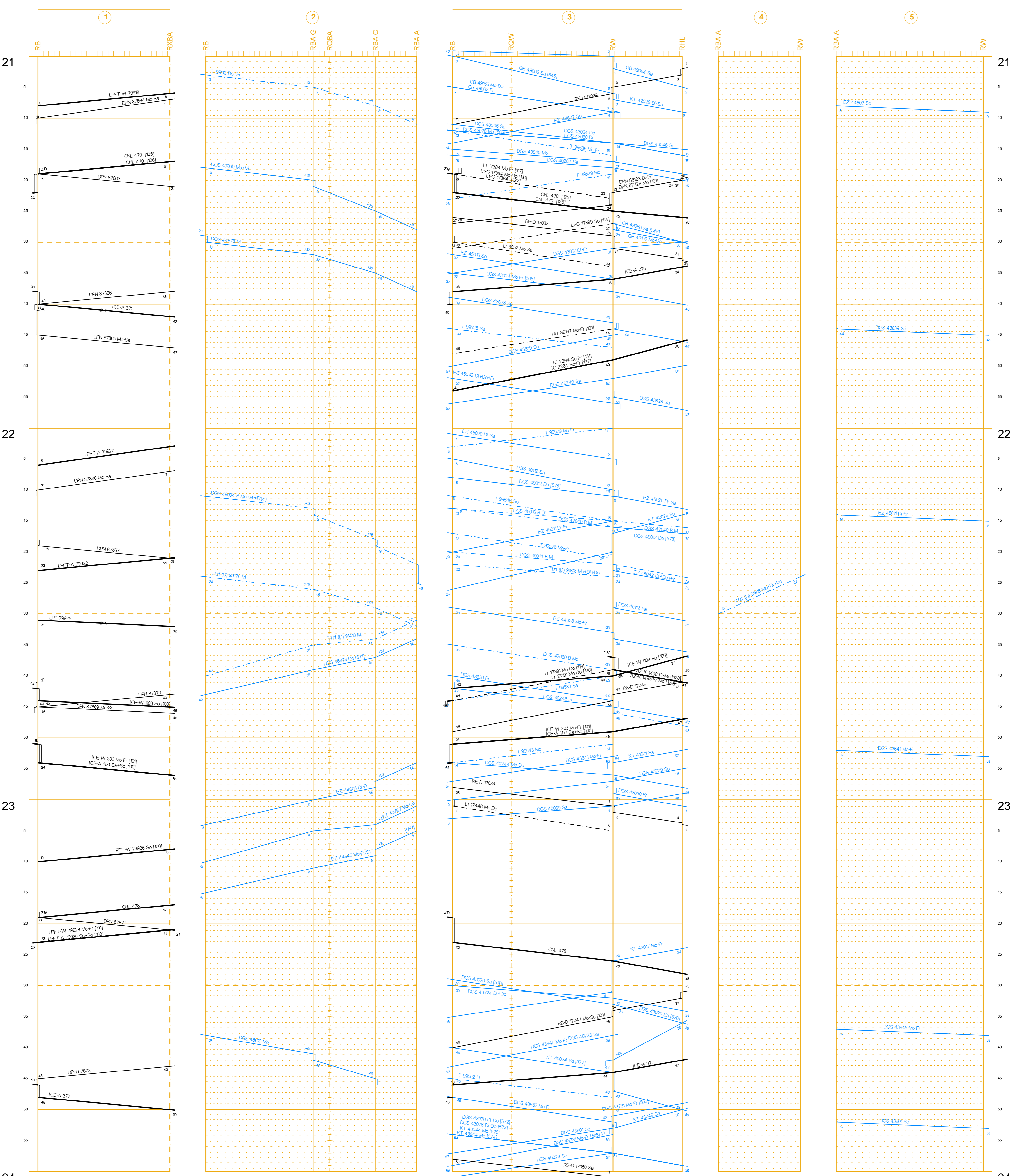

[100] auch: 3.10.16
 [101] nicht: 3.10.16
 [114] 5.9.16 - 11.9.16 So
 [116] 12.9.16 - 20.9.16 Mo-Fr
 [117] 4.10.16 - 9.10.16 Mo-Fr
 [122] 5.9.16 - 11.9.16
 [125] 24.9.16 - 9.10.16
 [126] 5.9.16 - 23.9.16
 [127] 19.9.16 - 9.10.16 So-Fr
 nicht: 2.10.16
 [505] nicht: 3.10.16
 [545] nicht: 1.10.16
 [549] Gl 70
 [571] 6.10.16 - 9.10.16 Do
 [572] 5.9.16 - 1.10.16 Di-Do
 [573] 2.10.16 - 9.10.16 Di-Do
 [574] 5.9.16 - 1.10.16 Di-Do
 [575] 2.10.16 - 9.10.16 Mo
 [576] nicht: 24.9.16
 [577] nicht: 17.9.16, 1.10.16, 8.10.16
 [578] 3.10.16 - 9.10.16 Do
 [579] nicht: 1.10.16